



# DOOR COLLECTION

2025 - 2026

TOP CHOICE FOR INTERIOR DOORS



## THE FIRST DOOR

In the early days, when people left their nomadic lives to start settling down, they used stone, wood, and animal skins to cover caves, protecting themselves from wild animals and harsh weather.



Ancient Times

## APPEARANCE OF SOPHISTICATION

Doors in the Middle Ages were no longer simply shields. They were elaborately carved, made of wood, bronze, or stone, reflecting the culture and construction technology of this period.

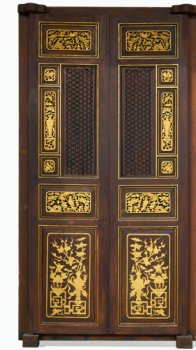

Middle Ages

## PERIOD OF MATERIAL EXPLOSION

During the Industrial Revolution, thanks to the advent of steel, glass, cast iron, industrial wood and alloys, many sustainable and modern designs were created to meet the needs of many different purposes.



Industrial Revolution Period

## REBIRTH & DEVELOPMENT

During the Renaissance & Baroque periods, doors became a statement of power and art, made of oak, reinforced with wrought iron, carved with Gothic and Baroque motifs.



Renaissance & Baroque

## 21ST CENTURY – DEWOO DOOR CONTINUES THE JOURNEY TO THE FUTURE

New era, new trends! The door industry is constantly innovating towards more optimal values - durable, aesthetic and user-friendly.

DEWOO DOOR is a pioneer in bringing the Composite wood-plastic door line, inheriting traditional values combined with modern technology, opening a new era for living space.

Each DEWOO DOOR product is not just a door, but also a symbol of style, quality and timeless innovation.







DEWOO DOOR is a leading brand specializing in the manufacturing and supply of premium interior doors, operating with a state-of-the-art production system across three factories spanning a total area of 30,000 m<sup>2</sup>.

DEWOO DOOR delivers high-performance composite wood-plastic door solutions that offer durability, aesthetic appeal, and optimal functionality for every modern living space.

We are committed to crafting doors that not only open up spaces, but also unlock enhanced living values and long-lasting peace of mind for every project.



100%  
Waterproof



Durable



Soundproof



Scratch-resistant



Termite-proof



100%  
Eco-friendly

| White Edging

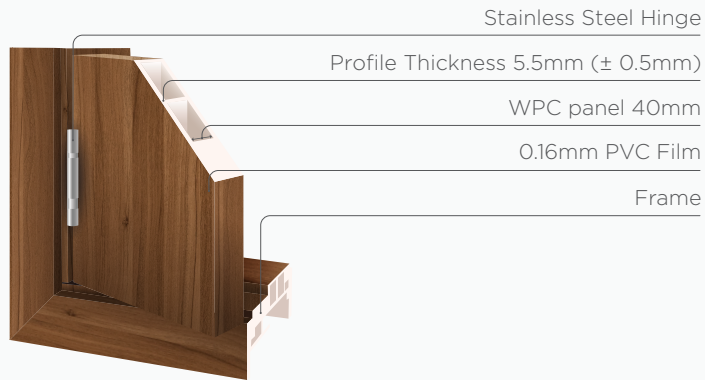

| Black Edging

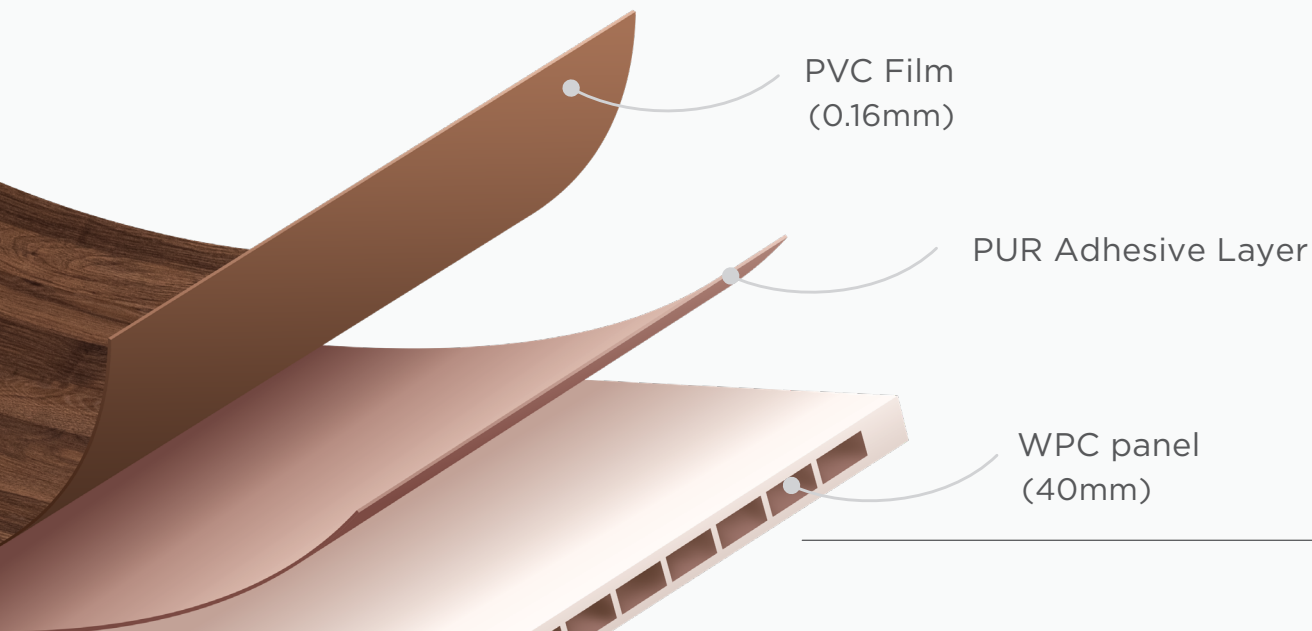
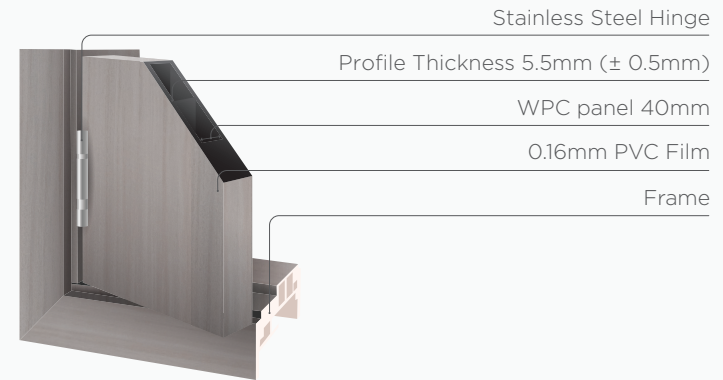

Scan the QR code to view the cross-section file of DEWOO DOOR products.





Woodgrain  
Texture

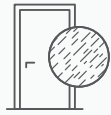

Sand  
Texture

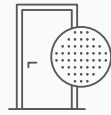

Smooth  
Texture



Multi-Pattern



Unequal  
Double Door



Door With  
Top Fixed Panel

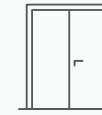

Double  
Door

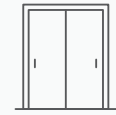

Sliding  
Door



CNC



Aluminum  
Strip



Moulding



Glass



Louver



Rosette  
Lock



Lever  
Lock



Pull  
Handle

SPECIFICATIONS	DOOR TYPE	WIDTH	HEIGHT	MAXIMUM OVERSIZE
	Unequal Double Door	<1300mm	<2250mm	2200X2450mm
	Double Door	1010 - 1730mm	<2250mm	
		1731 - 1930mm	<2250mm	
	Single Sliding Door	<800mm	<2200mm	1050x2400mm
		800 - 900mm	<2200mm	
		901 - 1050mm	<2200mm	
	Single Door	<800mm	<2250mm	1140x2450mm
		800 - 900mm	<2250mm	
901 - 1080mm		<2250mm		

For heights exceeding the maximum, doors can be designed with a top fixed panel (except sliding doors).

# 2025 DOOR DESIGN TRENDS

Subtle decorative stripes create a gentle accent on light woodgrain backgrounds. The combination of moulding and glass creates a soft, refined appearance. Subtle CNC details beneath the surface add artistic depth and modern creativity. Bold CNC designs on black panels offer a modern and distinctive style.



DECORATIVE STRIPES



MOULDING WITH GLASS



CNC UNDERLAY



CNC ON BLACK PANEL

# VARIOUS DOOR STYLE



ARCHED  
DOOR



GLASS  
DOOR



FLAT  
DOOR



DOOR  
WITH  
FIXED  
LOUVER  
PANEL



DOOR  
WITH  
LOUVER



DOOR  
WITH  
TOP  
FIXED  
PANEL



DOUBLE  
DOOR



DOUBLE  
SLIDING  
DOOR



SINGLE  
SLIDING  
DOOR



# VELAR

Shelter and protection, luxury and mystery.  
Like a delicate curtain, Velar covers the space with timeless class.

DW C101  
M26 - M30

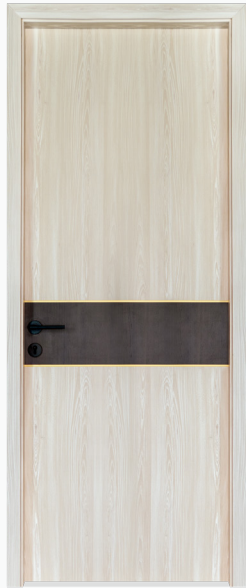

DW C201  
S410 - M35



DW C101  
M26 - M30



DW H013  
S448



DW H012  
S388



DW T301  
S388



DW C102  
S388

# SNOW WHISPER



The sophistication of white snow, gentle and pure like a winter breeze, honoring the beauty of minimalism, luxury and sophistication, bringing an elegant and graceful interior space.



DW T302  
M11



DW P501  
M11



DW P502  
M11

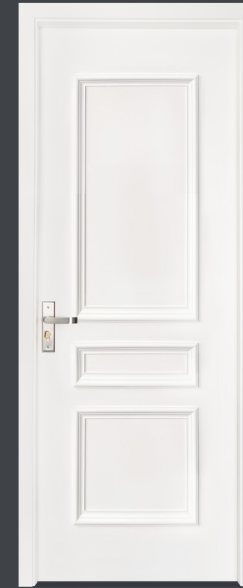

DW P503  
M11



DW K640-P505  
M11



DW H037  
M11



DW T302  
M11

# FUMO DOLCE

The interaction between the magical smoke and the delicate sweetness. The gentle neutral color scheme gives a modern and elegant beauty, enhancing the unique temperament of the living space.

DW K630  
M68



DW T302  
M69



DW H024  
M68





DW C112  
M68



DW H024  
M68



DW K630  
M68



DW H119  
M69



DW T302  
M69



DW H108  
M69



DW S715  
M50

# UMBER LUXE

The warm, earthy brown color of Mid-Century Modern brings a fusion between classic and modern, turning the space into a declaration of class and trendy aesthetic taste.



DW C102  
S612



DW C201  
M35



DW S715  
M50



DW C109  
M19



DW C108  
M35



DW S716  
M50

# ORIENTAL SUN

Bringing the radiant Eastern sunlight,  
evoking warmth and energy, brightening up  
the living space in an attractive and unique way.

DW H037  
M27





DW H011  
S911



DW H010-P502  
S911



DW H010-P502  
S911



DW H037  
M27



DW H037-L100  
M27

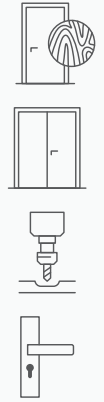

DW H037  
M27

# SLATE SYMPHONY

A symphony of modern gray, where minimalist design blends with delicate lines. Honoring the elegant, luxurious and timeless beauty.



DW H134  
M30





DW H018  
M30



DW H108  
M30



DW H134  
M30



DW K610  
M29



DW S614  
M29



DW S615  
M29

# EBONIQUE

Mysterious, sophisticated and powerful dark color. It is like deep ebony combined with minimalist European style, Ebonique bringing luxurious, powerful beauty, improving the classy living space.



DW C203  
M12





DW C203  
M12



DW 000  
M32



DW C210  
S335



DW H063  
M12



DW H014  
M32



DW T302-H015  
S335

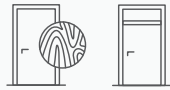

DW C102  
S613



DW K620  
S613



DW 000  
M37



DW 000  
S613



DW K610  
M37



DW 000  
M37



DW K640-P505  
M11

## ACCESSORIES: LEVER LOCK

304 Stainless Steel  
Model: SS032



Unit: mm

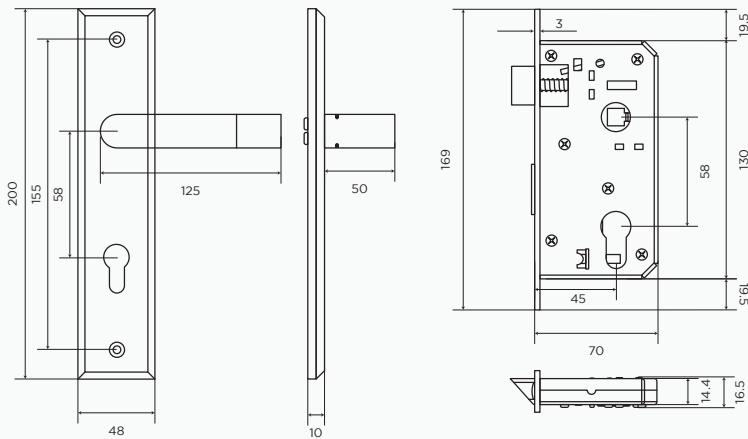

## ACCESSORIES: ROSETTE LOCK

Round Handle - INOX 304  
Model: SSF70



Unit: mm

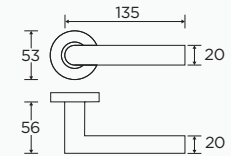

Flat Handle - INOX 304  
Model: SSF023\_SS

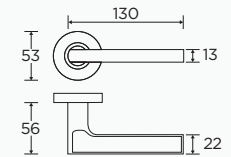

Flat Handle - Black Aluminum Alloy  
Model: SSF023\_BLACK

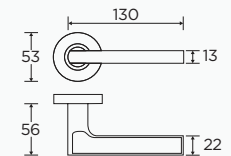

Flat Handle - Gold Aluminum Alloy  
Model: A9852-08

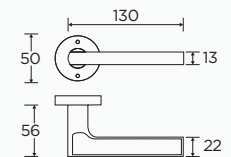

# ACCESSORIES: ALUMINUM STRIP

Straight Aluminum Strip - Gold  
Model: T8\_GOLD



Straight Aluminum Strip - Black  
Model: T8\_BLACK



Straight Aluminum Strip - Silver  
Model: T8\_SILVER

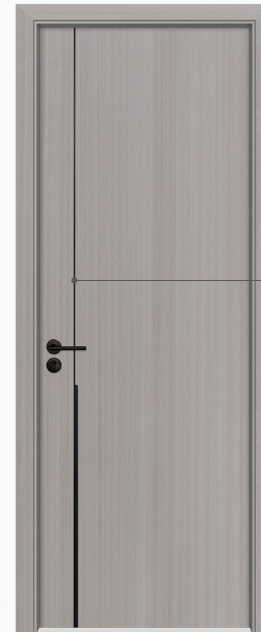
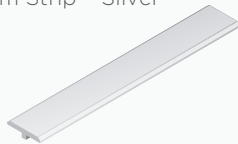

L Shaped Aluminum Strip - Gold  
Model: T18\_GOLD



L Shaped Aluminum Strip - Black  
Model: T18\_BLACK



L Shaped Aluminum Strip - Silver  
Model: T18\_SILVER



Unit: mm

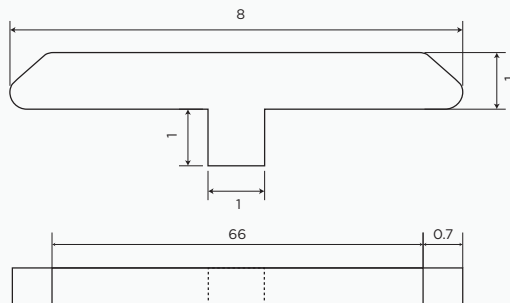

Unit: mm

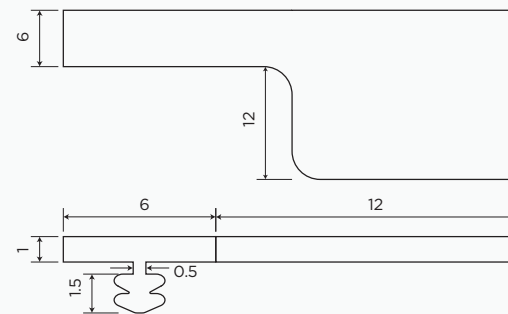

## ACCESSORIES: GLASS

### | Clear Glass

| Normal  
Tempered

5mm  
8mm



### | Frosted Glass

| Normal  
Tempered

5mm  
8mm



### | Corrugated Glass

| Normal

5mm  
8mm

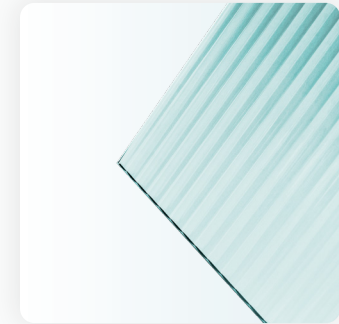

## ACCESSORIES: GLAZING BEAD

| Glazing Bead - Detail 1  
Unit: mm

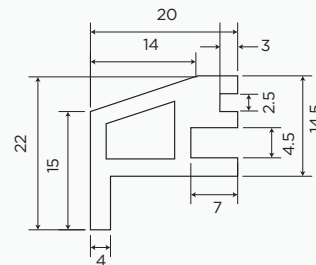
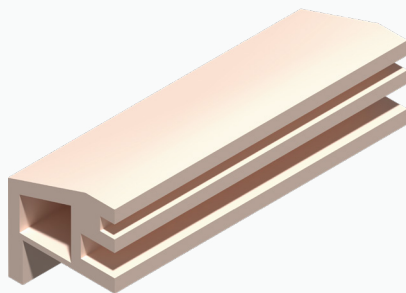

| Glazing Bead - Detail 2  
Unit: mm

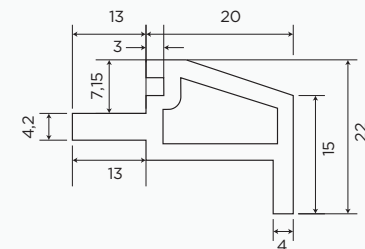
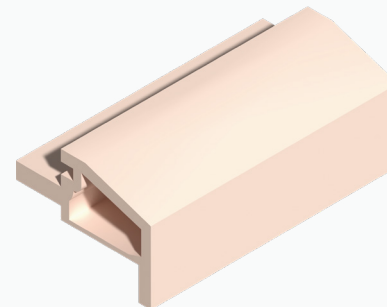

## ACCESSORIES: LOUVERS

Corrugated Louver  
Unit: mm

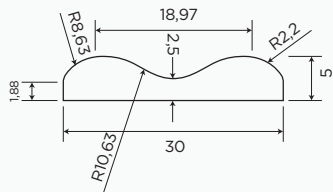
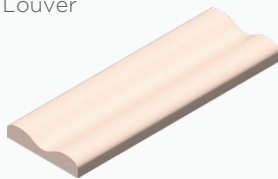

Rounded Corner Louver  
Unit: mm

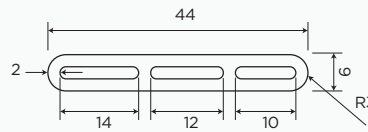

Square Louver  
Unit: mm

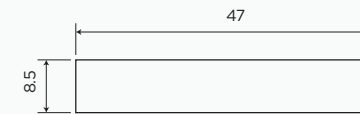
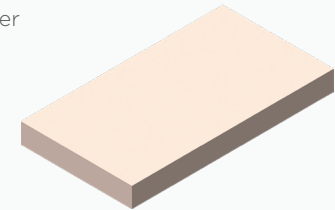

## ACCESSORIES: MOULDING

Hollow Moulding  
Unit: mm

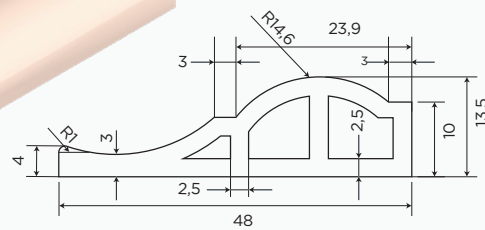
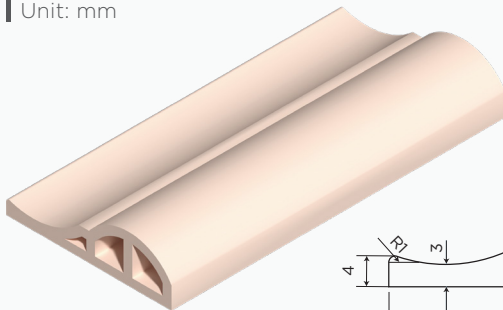

Solid Moulding  
Unit: mm

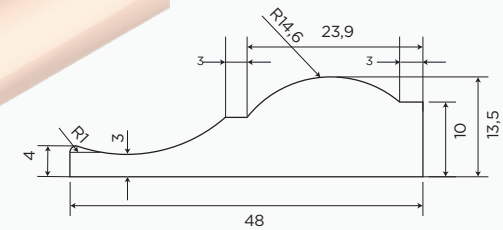
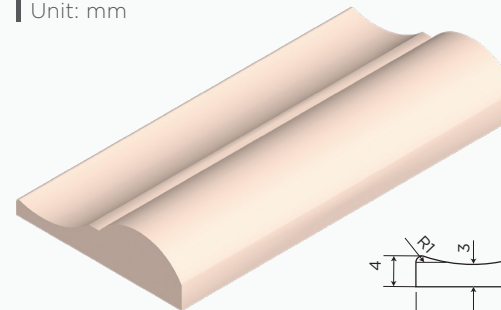

# 5 TYPES OF FRAME

Frame  
240x42

Unit: mm

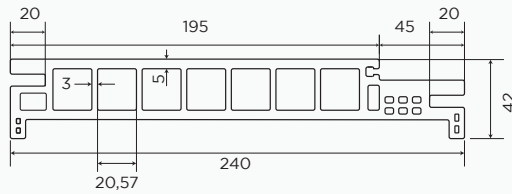
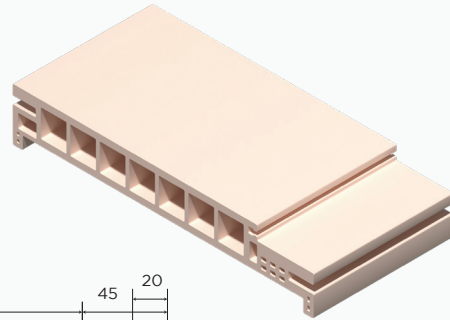

Frame  
200x42

Unit: mm

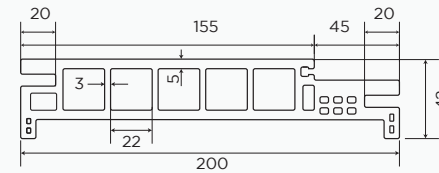
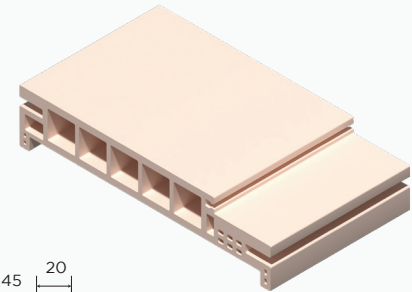

Frame  
160x42

Unit: mm

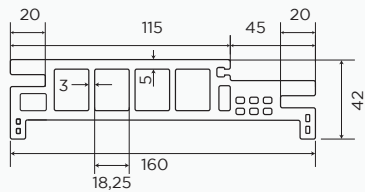
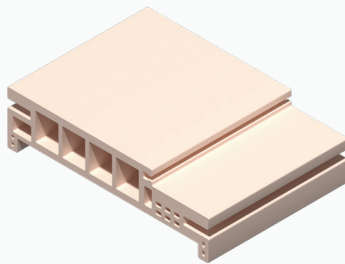

Frame  
125x42

Unit: mm

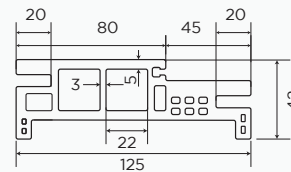
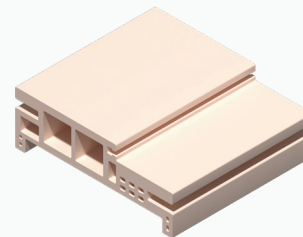

Frame  
100x42

Unit: mm

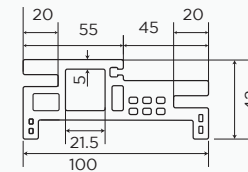
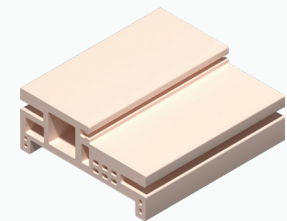



# CONQUERING THE MARKET

## EXPORT



LAOS



CAMBODIA



INDIA



SAUDI ARABIA



INDONESIA



MALAYSIA



THAILAND



PHILIPPINES

# WARRANTY POLICY



WARRANTY  
**5 YEARS**  
FOR DOOR



WARRANTY  
**2 YEARS**  
FOR ACCESSORIES

At DEWOO DOOR, we always put customer's satisfaction first. We not only provide high-quality door and accessory products, but are also committed to accompanying our customers throughout the product usage process.

DEWOO DOOR's reputation and reliability have been affirmed through thousands of large and small projects nationwide. DEWOO DOOR's products are always guaranteed transparently and clearly with a quick and effective support process.

# QUALITY CERTIFICATION



# SYNCHRONIZED

DEWOO DOOR door collection is perfectly synchronized with **ACCpanel** melamine board, creating a subtle unity in color and material. This blend enhances the class of the space, bringing luxury and uniformity to the interior design.



## VR360°

Scan the code to apply the DEWOO DOOR product combined with **ACCpanel** to your living space.



## INSTALLATION INSTRUCTIONS

Scan the QR code to watch the video for the detailed instructions for door installation and additional information of DEWOO DOOR.

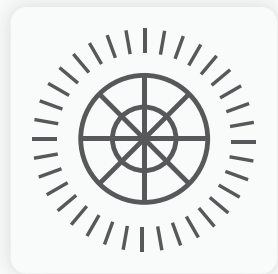

## DOOR COLOR MAP WAREHOUSE

Scan the QR code to download the door color map warehouse, helping architects and designers easily use it in drawings, perspectives and interior design projects.





**Head office:** Lot 8, Road No. 7, Dien Nam - Dien Ngoc Industrial Park, Dien Ban, Quang Nam

Hotline: **1900 252 248**

Email: [info@dewoogroup.com](mailto:info@dewoogroup.com)

Website: [dewoodoor.com](http://dewoodoor.com)

### **Factory**

- Factory 1: Lot 4, Road No. 3, Dien Nam - Dien Ngoc Industrial Park, Dien Ban, Quang Nam
- Factory 2: Lot 8, Road No. 7, Dien Nam - Dien Ngoc Industrial Park, Dien Ban, Quang Nam
- Factory 3: 2/1 Tan Phuoc Khanh 38 Street, Tan Phuoc Khanh, Tan Uyen, Binh Duong

### **Sales and Representative Offices**

- Representative office: 52 Nguyen Thi Nhung, Van Phuc Urban Area, Thu Duc City, Ho Chi Minh City
- Showroom: 102 Vo Chi Cong, Hoa Xuan, Cam Le, Da Nang City
- Sales office: National Highway 1A, Quang Chau Village, Hoa Phuoc, Hoa Vang, Da Nang City
- Sales office: National Highway 1A, Trung Nam Village, Dien Toan, Dien Khanh, Khanh Hoa
- Sales office: 219 Hung Vuong, Dong Ha City, Quang Tri
- Sales office: 147 Ly Thuong Kiet, Dong Hoi City, Quang Binh
- Sales office: 1462 Doan Nguyen Tuan, Tan Quy Tay, Binh Chanh, Ho Chi Minh City

© 2025 DEWOO DOOR. All rights reserved.

It is strictly forbidden to copy, edit or use part or all of the contents of this catalogue without written consent from DEWOO DOOR.

June 2025 Print.